



Trigger Module

User's Guide



Trigger Module

User's Guide

PM-U02

Copyright © Delsys Incorporated

Specifications and procedures outlined in this document are subject to change without notice.

Delsys Logo, EMGworks, and Myomonitor are Registered Trademarks of Delsys Incorporated.

MAN-005-1-2

- Important Information 5
 - Intended Use..... 5
 - Technical Service and Support..... 5
 - Warnings and Precautions..... 6
 - Device Information 7
 - Disclaimer 8
 - Limited Warranty..... 8
- Trigger Module Overview 9
- Trigger Module Usage Scenarios 12
 - Primary/Secondary Triggering Using the Trigger Module.. 13
 - Independent-Signal Triggering Using the Trigger Module . 14
- Operating the Trigger Module..... 15
 - Turning the Trigger Module “ON” 15
 - SP-U02 Model 15
 - SP-U05 Model 15
 - Start/Stop Trigger Input Options 16
 - Active Trigger Inputs..... 16
 - Passive Trigger Inputs..... 19
 - Push Button Inputs 20
 - Start/Stop Trigger Output Options 21
 - START Trigger Output..... 21
 - Stop Trigger Output 23
- Appendix - Synchronization and Triggering..... 25
 - The Need for Synchronization 25
 - Acceptable Delays 25
 - Constant vs. Variable Time Delays 26
 - The Concept of Triggering 27
 - Primary/Secondary Triggering 28
 - Independent-Signal Triggering..... 29
 - Common Signal Synchronization 30
 - Stop Triggers 30
- Specifications 31
 - Trigger Module..... 31
- Component References..... 32

Important Information

Intended Use

The Trigger Module is intended for research, investigational and scholarship purposes only. Delsys® products are not intended for measurement purposes or for use in the treatment and diagnosis of disease. Interpretation of the EMG signal by a qualified professional is required.

Technical Service and Support

For information and assistance visit our web site at:

www.delsys.com

Contact us at:

E-mail: support@delsys.com

tel: (508) 545 8200

Warnings and Precautions



Consult all accompanying documents for precautionary statements and other important information.



Consult accompanying user's guide for detailed instructions.



Keep the device dry. The presence of liquids may compromise the safety features of the device.



Handle with care.



Sensitive electronic device. Avoid static discharges. Do not operate or store near strong electrostatic, electromagnetic, magnetic or radioactive fields. Interference from external sources may decrease the signal-to-noise ratio or result in corrupted data.



This device may cause electrical disturbances in sensitive equipment within its operating environment.



Connect only to Delsys-approved devices.



Immediately discontinue device use if a change in the device's performance is noted. Contact Delsys technical support for assistance.



Delsys Inc. guarantees the safety, reliability, and performance of the equipment only if assembly, modifications and repairs are carried out by authorized technicians; the electrical installation complies with the appropriate requirements; and the equipment is used in accordance with the instructions for use.

Device Information



Do not dispose this product with house waste. Contact Delsys Inc. for instructions on responsibly disposing this device. This product should not be mixed with other commercial wastes.



Date of Manufacturing (appears on device)



Serial Number (appears on device)



DELSYS INC.
23 Strathmore Rd.
Natick MA 01760
USA

Manufacturer

Disclaimer

DELSYS INC. makes no warranties, express or implied, as to the quality and performance of this product including but not limited to, any implied warranty of applicability for other than research uses by qualified individuals. DELSYS INC. shall not be liable to any person for any medical expenses or any direct or consequential damages resulting from any defect, failure or malfunction, whether a claim for such damages is based upon theory of warranty, contract, tort or otherwise. No representative, agent, or licensed practitioner is authorized to waive this disclaimer. DELSYS INC. makes no diagnosis or prescription by virtue of anything about this product.

Limited Warranty

The Trigger Module is warranted against failure of materials and workmanship for a period of 1 year from the date of delivery, provided that the product is given proper care and has not been subject to abuse during this period. This warranty is in lieu of all other warranties expressed or implied. Operation of this device outside specifications determined by DELSYS INC. or use with any other input devices other than DELSYS INC. sensors constitute an invalidation of this limited warranty. This warranty is not transferable.

Trigger Module Overview

EMGworks[®] Data Acquisition and Analysis Software offers full triggering capabilities to control the start and stop of all data acquisition systems in a given experimental setup. The following trigger functions are available in EMGworks:

<i>Start In</i>	Starts data collection on a +5V rising edge
<i>Stop In</i>	Ends data collection on a +5V rising edge
<i>Start Out</i>	Outputs a +5V pulse once data collection is started
<i>Stop Out</i>	Outputs a +5V pulse once data collection is stopped

A Trigger Port is available on Trigno[™], Bagnoli[™] 4, 8, and 16 Channel EMG Systems, as well as the Myomonitor[®]. The Trigger Port gives the user access to the four trigger functions.

The Trigger Module was designed in order to facilitate connections to the Trigger Port. It offers full signal conditioning to ensure that input signals are properly configured for Delsys hardware and that output signals are properly configured for secondary equipment.

There are two different Trigger Module models depending on the EMG system: SP-U02 for use with Bagnoli and Trigno Systems and the SP-U05 for use with the Myomonitor IV System.



Figure 1. Trigger Module (SP-U02 model)

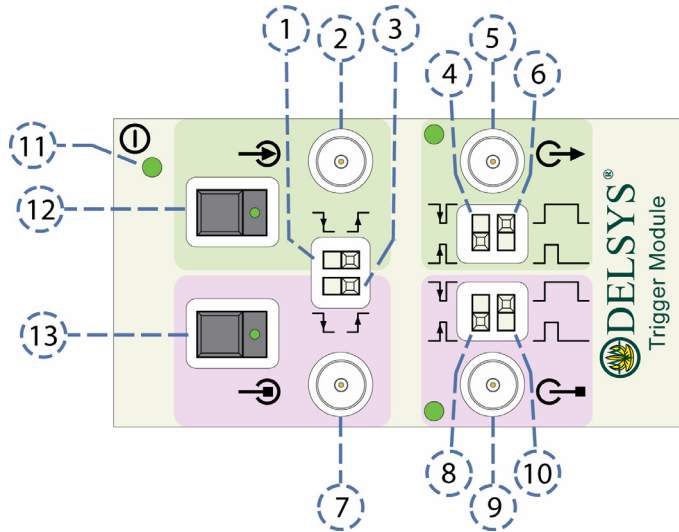

Figure 2. Trigger Module features and functions.

- 1 **START Input Edge Selector**
- 2 **START Input BNC Connector**
- 3 **STOP Input Edge Selector**
- 4 **START Output Polarity Selector**
- 5 **START Output BNC Connector**
- 6 **START Output Pulse Length Selector**
- 7 **STOP Input BNC Connector**
- 8 **STOP Output Polarity Selector**
- 9 **STOP Output BNC Connector**
- 10 **STOP Output Pulse Length Selector**
- 11 **Power Indicator**
- 12 **Push button START Trigger**
- 13 **Push button STOP Trigger**











	Power Indicator / Switch
	START Trigger Input
	START Trigger Output
	STOP Trigger Input
	STOP Trigger Output
	Rising Edge Input
	Falling Edge Input
	Positive Output Pulse
	Negative Output Pulse
	Short Output Pulse (~300 us)
	Long Output Pulse (~1s)

Table 1: Trigger Module Symbols.

Trigger Module Usage Scenarios

The Trigger Module can be used in two different types of triggering schemes: **Primary/Secondary Triggering** and **Independent-Signal Triggering**. Please consult the **Appendix - Synchronization and Triggering** for important information if you are new to these subjects.

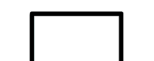
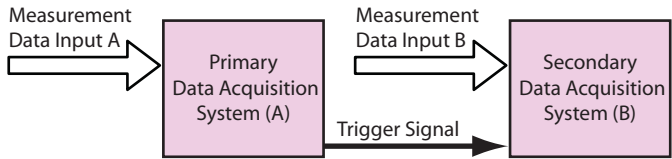

Figure 3. Primary/Secondary Triggering: In this triggering scheme a Primary Data Acquisition System is used to control a Secondary Data Acquisition System.

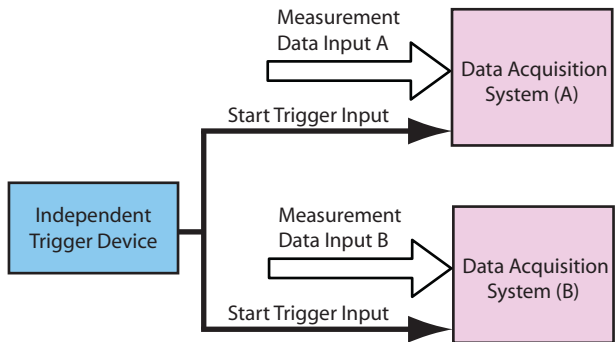

Figure 4. Independent-Signal Triggering: In this triggering scheme an independent trigger device is used to generate a signal to start both Data Acquisition Systems.

Primary/Secondary Triggering Using the Trigger Module

In order to best understand the operation of the Delsys Trigger Module in Primary/Secondary Triggering, it is useful to identify the components in a connection scheme:

Primary Data Acquisition System: This is the component that controls the starting and stopping of all other data acquisition components in an experiment setup. It can be thought of as the “Master” component that outputs all control signals.

Secondary Data Acquisition System: This is the component that is being controlled by the Primary Data Acquisition System. It can be considered to be the “Slave” since it responds only to signals from by the “Master” component.

EMGworks: This is the Delsys Signal Acquisition and Analysis package. It can be the Primary or Secondary System.

EMG System: All trigger signals to EMGWorks are input and output through the EMG System that it controls. This can be a Bagnoli 4, 8, or 16 Channel System or a Myomonitor.

Trigger Module: This is the component that ensures proper communication and integration between the Primary (Master) and Secondary (Slave) Data Acquisition Systems through signal conditioning.

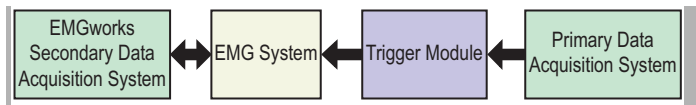

Figure 5. Primary/Secondary Triggering Scenario #1: Controlling EMGworks with other A/D Systems. In this case, another A/D System is the Primary Data Acquisition System and is used to trigger EMGworks as the Secondary System. The Start/Stop Trigger Output from the Primary Data Acquisition System is connected to the Start/Stop Trigger Input of the Trigger Module and the Trigger Module is connected to the EMG System.

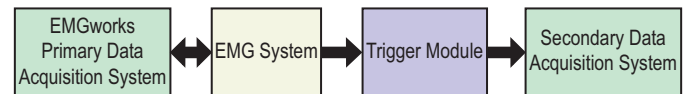

Figure 6. Primary/Secondary Triggering Scenario #2: Controlling A/D Systems with EMGworks. In this case, EMGworks is the Primary Data Acquisition System and is used to trigger a Secondary System. The EMG System is connected to the Trigger Module and the Start/Stop Trigger Output from the Trigger Module is connected to the Start/Stop Trigger Input of the Secondary Data Acquisition System.

Independent-Signal Triggering Using the Trigger Module

In the Independent-Signal Triggering scenario, the Trigger Module is used as a push button device. It is used to start both EMGworks and another A/D System.

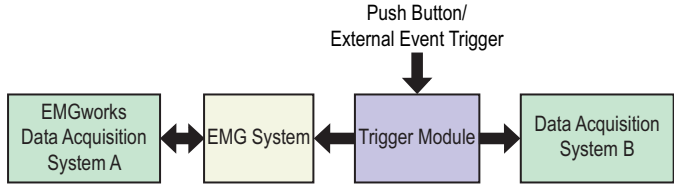

Figure 7. Independent-Signal Triggering Scenario: Controlling all A/D Systems with External/Manual Events. In this case, the Trigger Module is used as a push button device to start both EMGworks and another Data Acquisition System. The Trigger Module is connected to the EMG System and the Start/Stop Trigger Output from the Trigger Module is connected to the Start/Stop Trigger Input of the other Data Acquisition System.

Operating the Trigger Module

Turning the Trigger Module “ON”

SP-U02 Model

The SP-U02 model is used with the Trigno and Bagnoli Systems. Power to the Trigger Module is supplied by the cable that connects to the EMG system and must be connected prior to activating the device.

1. Connect the Trigger Module Cable to the Trigger Port located on the EMG System.
2. Turn on the EMG System. (The EMG System must have already been set up properly for use. For Bagnoli systems, this includes the proper installation of the National Instruments A/D card in the computer being used).
3. Flip the toggle switch on the front panel of the Trigger Module to the “ON” position. The green power LED on the Trigger Module will illuminate to indicate that the device is powered.

SP-U05 Model

The SP-U05 model is used with the Myomonitor IV device. This model provides galvanic isolation so that the EMG System remains isolated from any other equipment connected to the building ground potential and mains voltage grid. This feature requires additional power from a 9V battery.

1. Install a 9V battery in the Trigger Module battery compartment.
2. Connect the Trigger Module Cable to the Trigger Port on the Myomonitor.
3. Turn on the Myomonitor EMG System.
4. Flip the toggle switch on the front panel of the Trigger Module to the “ON” position. The green power LED on the Trigger Module will illuminate to indicate that the device is powered.

Start/Stop Trigger Input Options

Active Trigger Inputs

Trigger input signals can be connected to the Trigger Module to START or to STOP data acquisition in EMGworks. This corresponds to Scenario #1 in the Trigger Module Usage Scenarios. The trigger signals are typically generated from hardware in the experimental setup that is intended to operate in synchrony with Delsys equipment. Active trigger input signals consist of pulses that are driven between 0 Volts and 5 Volts. The Trigger Module can be configured to trigger events on either positive-edge signals or negative-edge signals.

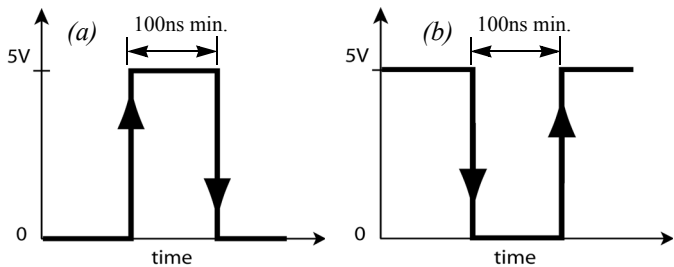

Figure 8. a) Positive-edge or “rising” signal. (b) Negative-edge or “falling” signal. In both cases, the Trigger Module requires a minimum input pulse width of 100 ns in order to guarantee the proper registration of the event.

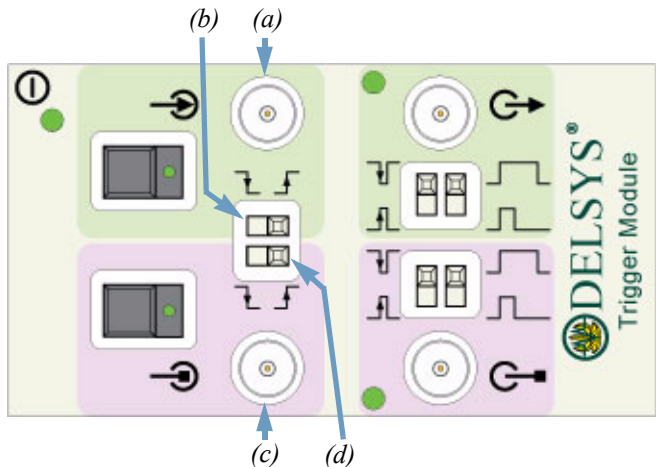

Figure 9. Key Active Trigger Input Components of the Trigger Module. (a) START Input Signal Connector, (b) START Input Edge Selector, (c) STOP Input Signal Connector. (d) STOP Input Edge Selector.

Positive-edge or “rising” trigger input signals start from 0V and rise to 5V. The system generating the trigger signal MUST be connected to 0V prior to the 5V trigger event, and cannot be floating (that is unconnected to any voltage potential). It is the transition from 0V to 5V that defines the event. Once the 5V level is reached, the trigger pulse must be kept in the high state for a minimum amount of time before returning back to the low state. The Delsys Trigger Module requires a minimum pulse duration of 100ns (10^{-7} s). The trigger pulse length should never exceed the duration of the data acquisition set, however, and must be reset to the 0V level before the system can be re-triggered.

Configure the Trigger Module to accept positive-edge trigger input signals by placing the Input Edge Selector to the “rising” position. Pay careful attention to the switch location for the START trigger input (indicated by the light green shading) and the STOP trigger input (indicated by the light violet shading). This is important because there may be cases when a “rising” edge signal is to be used to start acquisition and a “falling” edge signal is to be used to stop acquisition or vice versa.

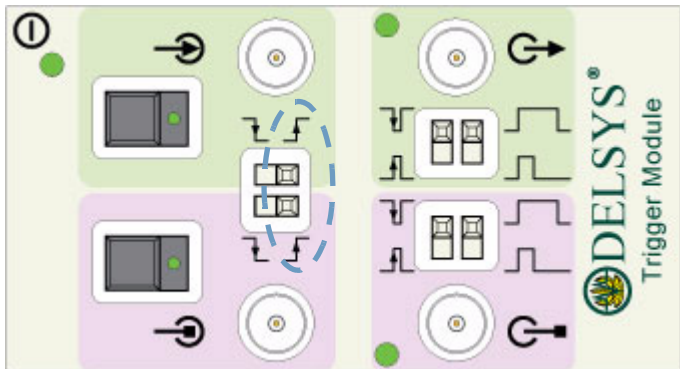

Figure 10. Setting the Trigger Module to accept “rising” edge trigger input signals. The “rising” edge is selected with the Input Edge Selector for START or STOP in the position circled in the diagram. Note that the above figure is only representative and may vary with different device models.

In contrast, negative-edge or “falling” trigger input signals start from the 5V level and drop to 0V at the trigger event. The system generating the trigger signal **MUST** be connected to 0V at the time of the trigger event and cannot be floating. The Trigger Module again requires a minimum pulse duration of 100ns. The trigger pulse length should never exceed the duration of the data acquisition set, however, and must be reset to the 5V level before the system can be retriggered.

Configure the Trigger Module to accept negative-edge trigger input signals by placing the Input Edge Selector to the “falling” position. Pay careful attention to the switch location for the START trigger input (indicated by the light green shading) and the STOP trigger input (indicated by the light violet shading). This is important because there may be cases when a “rising” edge signal is to be used to start acquisition and a “falling” edge signal is to be used to stop acquisition or vice versa.

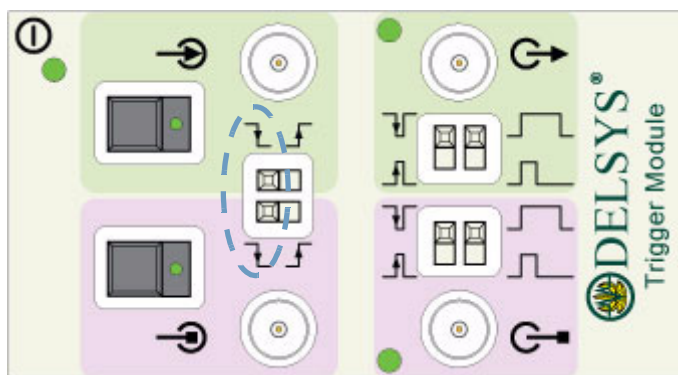

Figure 11. Setting the Trigger Module to accept “falling” edge trigger input signals. The “falling” edge is selected with the Input Edge Selector for START or STOP in the position circled in the diagram. Note that the above figure is only representative and may vary with different device models.



CAUTION: All trigger input signals must never exceed 5 Volts, as damage to the Trigger Module and other hardware could result.

Passive Trigger Inputs

In addition to accepting active trigger inputs, where signals are driven between 0V and 5V as described in the previous section, the Trigger Module can also accept passive trigger input signals. These inputs are defined by the presence or absence of a 0V signal. A simple switch can be used to generate a passive trigger input signal by either connecting an open switch to 0V or by opening a closed switch that is connected to 0V. Either implementation can be achieved by connecting (or disconnecting) the BNC shell to the center pin of BNC input connector. More sophisticated implementations can make use of electronic circuits that perform the same function as a passive switch, such as transistors.

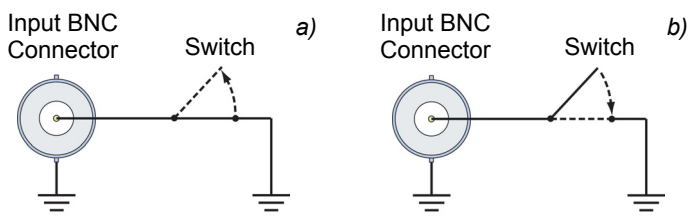

Figure 12. Passive Trigger Inputs: a) Disconnecting the 0V potential at the event of interest, b) Connecting the 0V potential at the event of interest.

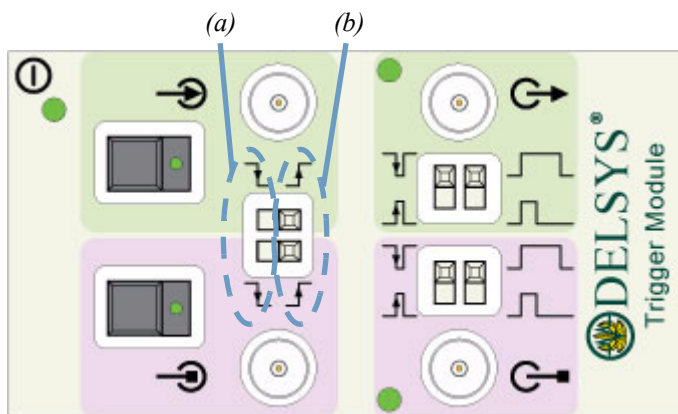

Figure 13. Passive Trigger Input Settings: (a) Use the **falling** edge position of the START or STOP Input Edge Selector when **connecting** 0V from the BNC input. (b) Use the **rising** edge position of the START or STOP Input Edge Selector when **disconnecting** 0V to the BNC input. Note that the above figure is only representative and may vary with different device models.



CAUTION: The center pin of the Output BNC connector must never be connected to the BNC shell or to the 0V potential as this may damage the Trigger Module.

Push Button Inputs

Two push buttons are provided to allow for remote manual START and remote manual STOP signals to EMGworks. The trigger signal is sent as soon as switch contact occurs. A green led on the button illuminates for approximately 1/2 second once a valid signal is sensed. The push button triggers will only function when the corresponding Input Edge Selector is set for a “rising” edge.

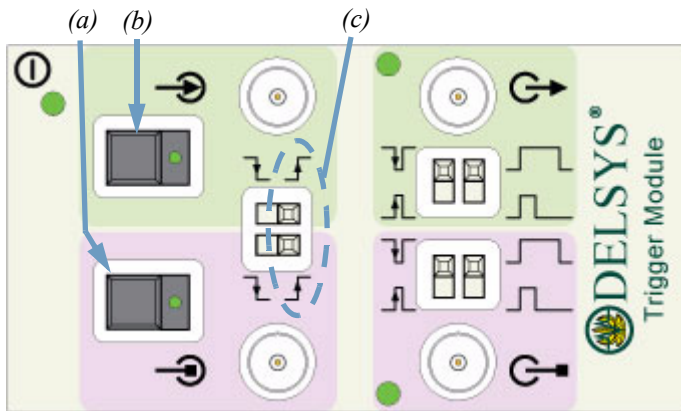

*Figure 14. Configuring the Trigger Module for Push button START and STOP commands. (a) STOP Push button, (b) START Push button, (c) START and STOP Input Edge Selectors must be set to the **rising** edge position for the Push buttons to operate. Note that the above figure is only representative and may vary with different device models.*

Start/Stop Trigger Output Options

START and STOP trigger output signals can be generated from EMGworks in order to control other hardware in an experimental setup. This corresponds to Scenario #2 in the Trigger Module Usage Scenarios. The signals can be configured by the Trigger Module to be positive or negative pulses and can be configured to be long (75 ms) or short (150 ns). These signals are accessible from START and STOP Output BNC connectors on the module.

START Trigger Output

A START trigger output signal is generated at the same instant that EMGworks begins to acquire data. Data acquisition in EMGworks can begin in one of the following ways:

- a manual keyboard or mouse command in EMGworks
- a predetermined command in an EMGworks Test
- a START trigger input signal.

The START trigger output signal is an active signal, so that at any point in time it is either connected to 0V or to 5V. It can be a positive signal (rising from 0V to 5V) or a negative signal (falling from 5V to 0V), determined by the position of the START Output Polarity Selector. Additionally, it can be a short pulse of about 300us or a long pulse of about 1s, as determined by the START Output Pulse Length Selector.

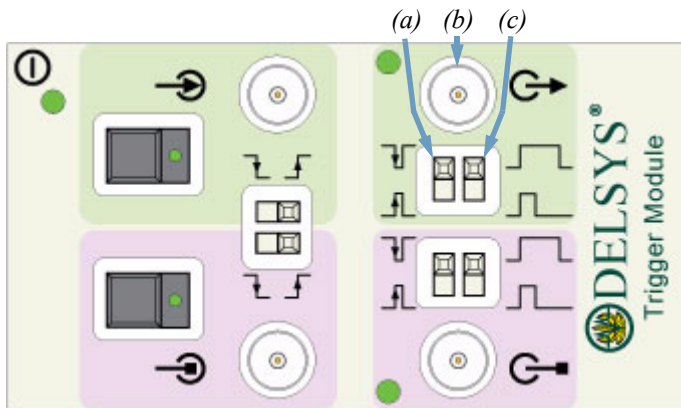

Figure 15. Configuring the START trigger output signal (a) START Output Polarity Selector. (b) START Output BNC connector, (c) START Output Pulse Length Selector. Note that the above figure is only representative and may vary with different device models.

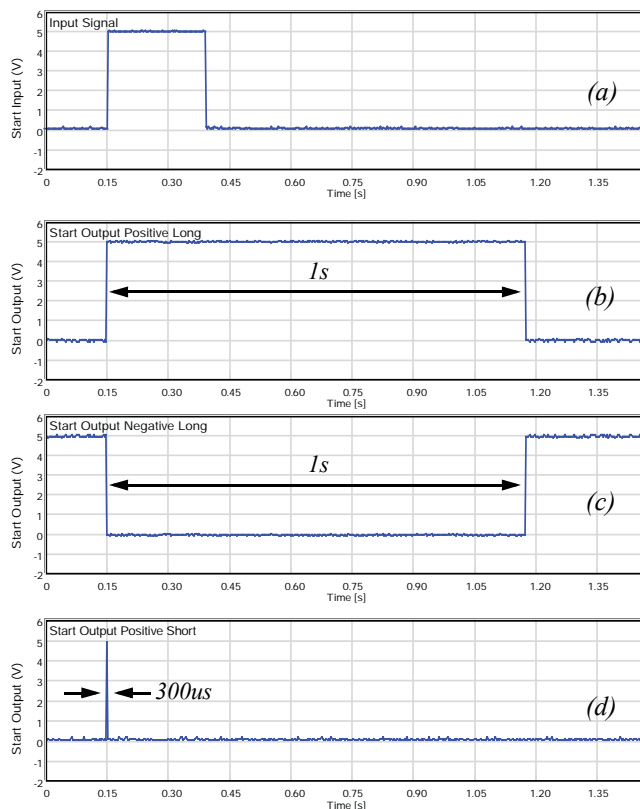

Figure 16. START trigger output signals synchronized with a START trigger input signal. (a) Example START trigger input signal, (b) Typical START output positive long pulse, (c) Typical START output negative long pulse, (d) Typical START output positive short pulse.

The choice of whether to use a positive output pulse or a negative output pulse and whether to use a short pulse or a long pulse will depend entirely on the additional hardware that is to be controlled by EMGworks.



Please consult the documentation for your additional hardware to determine the appropriate trigger output signals.



Note that the long and short pulse lengths can vary up to 20% depending on hardware impedances and signal timing.

Stop Trigger Output

A STOP trigger output signal is generated as soon as EMGworks processes a command to stop data acquisition. Data acquisition can stop in any of the following ways:

- a manual keyboard or mouse command in EMGworks
- a predetermined command in an EMGworks Test,
- a STOP trigger output signal

The STOP trigger output signal is an active signal, so that at any point in time it is either connected to 0V or to 5V. Like the START trigger output signal, it can be a positive signal (rising from 0V to 5V) or a negative signal (falling from 5V to 0V), determined by the position of the STOP Output Polarity Selector. Additionally, it can be a short pulse of about 300us or a long pulse of about 1s, as determined by the STOP Output Pulse Length Selector.

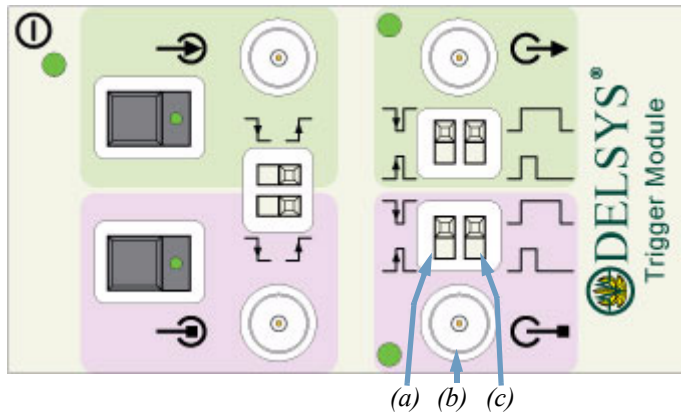

Figure 17. Configuring the STOP trigger output signal (a) STOP Output Polarity Selector. (b) STOP Output BNC connector, (c) STOP Output Pulse Length Selector. Note that the above figure is only representative and may vary with different device models.

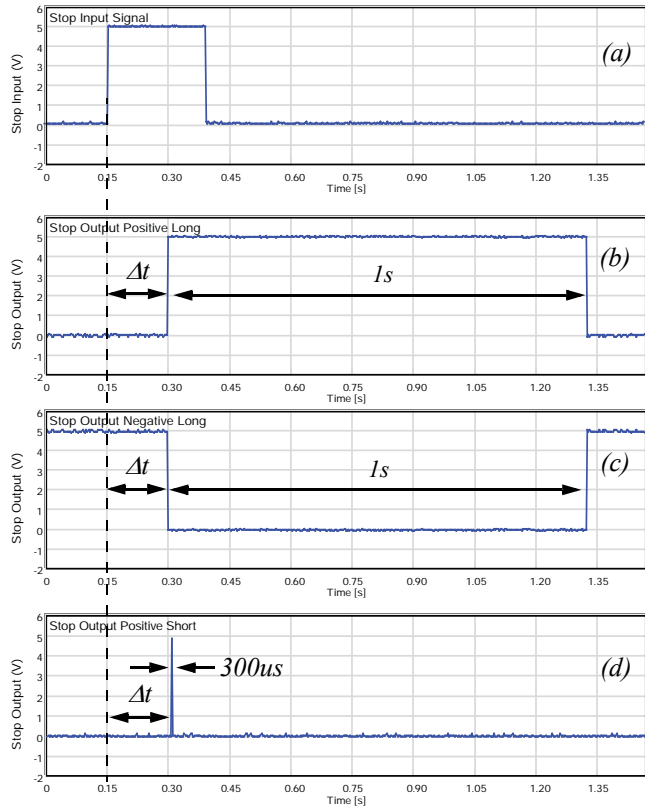

Figure 18. STOP trigger output signals synchronized with a STOP trigger input signal. (a) Example STOP trigger input signal, (b) Typical STOP output positive long pulse, (c) Typical STOP output negative long pulse, (d) Typical STOP output positive short pulse. Note that the delay, Δt , between STOP trigger input signal and the STOP trigger output pulse is dependent upon the specifications of the computer and on internal operating system parameters. This time delay can range from 10 ms to 500 ms.

Appendix - Synchronization and Triggering

The Need for Synchronization

Physiological studies often utilize a variety of specialized measurement systems in experimental designs. The ideal case employs a single data acquisition system that records all necessary data types, inherently time-synchronizing all measurements. In many cases, however, it is necessary to have multiple data acquisition systems that are specifically designed for only one type of measurement. An example that is often encountered in the Biomechanics field is the need to record EMG data from the body's muscles as well as Motion Capture data from the body's movements. It is important to ensure that an EMG event detected by the EMG system is correlated to the corresponding biomechanical event detected by the Motion Capture system at the same point in time. In order to ensure this, the Motion Capture system must start at the same time that the EMG data acquisition system starts, so that no effective delay is observed between the two.

Acceptable Delays

The ability to discern the time delay between data acquisition systems is determined by the lowest sampling frequency. For example, the typical sampling rate for a surface EMG signal is 1000 samples/second, which constitutes a sampling period of 1 ms. A Motion Capture systems may sample at 100 frames/second, corresponding to a sampling period of 10 ms. In this case, a synchronization delay of 10 ms or less would be virtually undetectable, since the Motion Capture system is not able to resolve a time quantum smaller than this value. From a practical perspective, time delays up to several hundred milliseconds may be acceptable for physiological measurements, depending on the nature of the investigation.

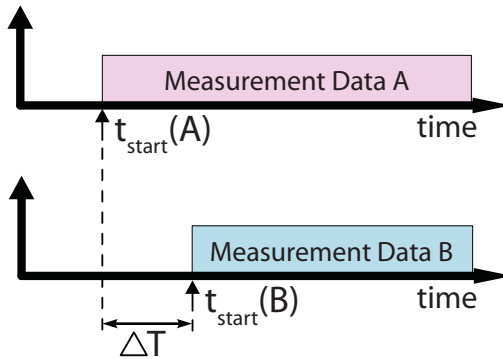

Figure 19. Time Delay Between the Start of Data Acquisition Systems. It is important to ensure that this time delay is minimized to an acceptable period.

Constant vs. Variable Time Delays

An important distinction between *constant delays* and *variable delays* must be understood. In some cases, the delay between data acquisition systems is a known, constant quantity, usually inherent in one of the measurement systems. A constant time delay is a benign inconvenience that can be corrected during data analysis. For example, if it is known that Motion Capture Data is always measured with a 100 ms delay with respect to the EMG data, then the data can be shifted in time by this same amount during analysis so that the information presented is time-synchronized.

Time delays that are variable in measurement systems are usually unknown to the investigator, and thus pose greater difficulty in their management. These types of delays are often introduced by software processes that are intrinsic to computer operation and cannot be controlled by data acquisition systems. In some cases an upper limit can be placed on these delays. These upper limits are usually a statistical average and must be treated as such. If this upper bound is smaller than the largest sampling period, or if it is otherwise an acceptable time period for the experimental design, then it can be effectively ignored. If, however, this upper bound is too large or unknown, then a synchronization strategy must be implemented to manage the delay. Fortunately, most data acquisition systems offer a variety of strategies for minimizing, and, in some cases, completely eliminating time delays.

The Concept of Triggering

The key to implementing a successful triggering strategy is to establish a control signal that is capable of immediately starting data acquisition on one or more systems. The ability for a data acquisition system to start with a digital control signal is usually described as a **Start Trigger Input**. The ability for a data acquisition system to start other systems with a digital control signal is usually described as a **Start Trigger Output**. In most cases, the specifications of these control signals are 5V digital pulses whose polarity and width will vary for different manufacturers.

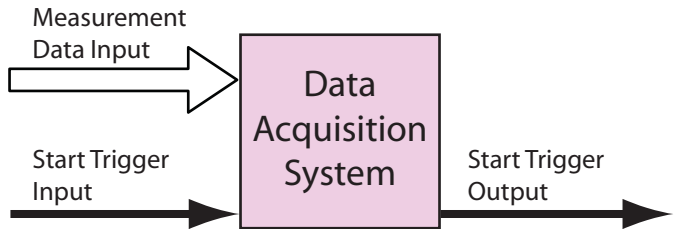

Figure 20. Important Signals in a Triggering Scheme. All data acquisition systems have an input for measurement data. Systems that have a Start Trigger Input can be started with a digital control signal. Those that have a Start Trigger Output can output a digital control signal when acquisition is started.

Primary/Secondary Triggering

A common strategy is to designate one data acquisition system as the primary device that controls all other data acquisition systems, the secondary devices. In this case, the **Primary Data Acquisition System** must have a **Start Trigger Output**, which is asserted the moment data sampling begins. This trigger signal is connected directly to the **Start Trigger Input** of the **Secondary System**, which initiates sampling on the second system. Note that it is possible to control more than one Secondary Data Acquisition System in this way. It may be necessary to condition the Start Trigger Output signal so that it can be interpreted correctly by the Secondary System, as dictated by the manufacturer's specifications.

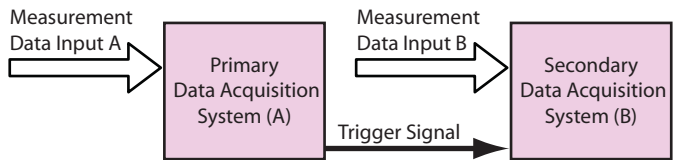

Figure 21. Triggering Scheme Using a Primary Data Acquisition System to Control a Secondary Data Acquisition System. The Start Trigger Output of the Primary System is directly input to the Start Trigger Input of the Secondary System so that when acquisition is started by the Primary System, it will signal the Secondary System to start.

Independent-Signal Triggering

For those systems that are **only** equipped with a **Start Trigger Input** feature, it is necessary to implement a control signal that is independent from the data acquisition systems in order to start them. In this scenario, all of the data acquisition systems are connected as Secondary Systems under the control of this independent device. This device could be a simple push-button switch or a digital control signal coming from a computer or other instrument.

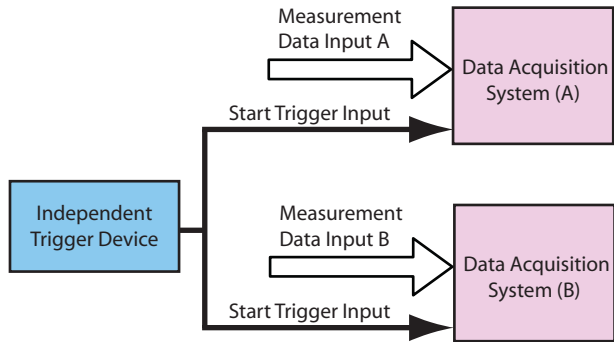

Figure 22. Triggering Scheme Using an Independent Trigger Signal to Start All Data Acquisition Systems. The same signal is input to the Start Trigger Input of all systems.

Common Signal Synchronization

In those cases where data acquisition systems do not support triggering functions, it may be possible to establish time synchronization of data by measuring a signal that is common to all systems. This is usually accomplished by sending an electrical pulse to one channel in each data acquisition system. All systems will record this electrical event on their respective channels, regardless of when the actual data sampling was started. A simple example of this technique might employ a 5V pulse that is activated by a push-button switch, which is sampled by all the active data acquisition systems. The time resolution of this technique is limited by the system which samples at the lowest rate, hence having the largest sampling period. Note that this approach may require each system to have a dedicated channel for observing the synchronization signal.

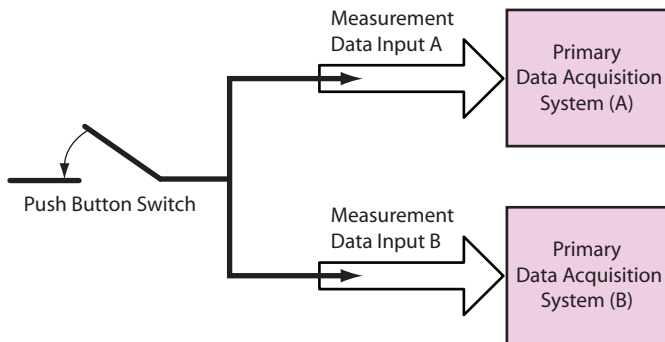

Figure 23. Synchronization Scheme for Data Acquisition Systems that Lack Start Trigger Inputs. A common signal, in this case a pulse from a push button, is input to one data channel in each data acquisition system. The data can then be synchronized during analysis using this common signal.

Stop Triggers

All of the triggering concepts discussed for synchronizing the start of data acquisition systems can be directly extended to situations requiring the synchronous stopping of data acquisition systems. Delays associated with Stop Triggers are not as critical as those affecting Start triggers, since they only dictate the length of the recorded data set and can be truncated as needed. Stop Trigger features can only be implemented with those devices that offer Stop Trigger Inputs and Stop Trigger Outputs.

Specifications

Trigger Module

General	
Dimensions	139.7 x 91.44 x 27.94 mm
Mass	233 g
Cable Length	3 m
Cable Connector	SP-U02: LEMO pn FGG.0B.306.CLAD56 SP-U05: Hirose pn 3240-8P-C(50)
Trigger I/O Connectors	BNC

Electrical	
Logic Level	5 V
Pulse Width Variability	+/- 10%
Power Consumption	TBD
Output Drive Current	TBD

Component References

Part Description	Part Number
Trigger Module Package (Bagnoli)	DS-U02
Trigger Module (Bagnoli)	SP-U02
Trigger Module User's Guide	PM-U02
Trigger Module Package (Myomonitor)	DS-U07
Trigger Module (Myomonitor)	SP-U05
9V Battery	SC-T01
Trigger Module User's Guide	PM-U02